

SLANT FACE PLENUM DIFFUSER

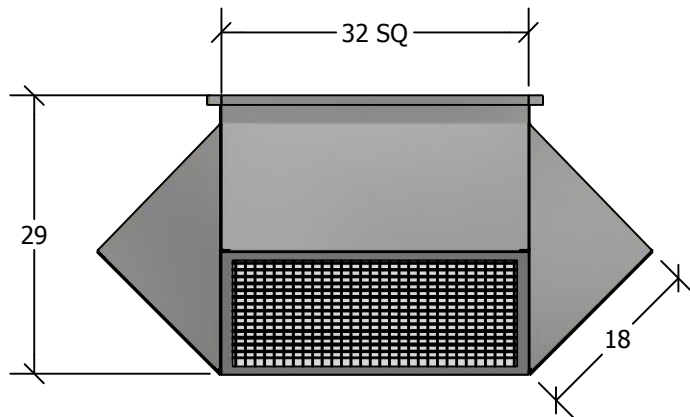

STANDARD FEATURES

1. G-90 Galvanized Steel Construction.
2. Turning Vanes in Each Quadrant.
3. 1" 1-1/2 lb. Duct Liner.
4. Vertical and Horizontal Adjustable Deflection Grilles.
5. Fully Assembled
6. TDC Duct Connections Provided.
7. 3/8" Threaded Inserts for Mounting Available.
8. Engineered Curb and Duct Packages Available.

NOM CFM 8,000	MODEL NO SFPD 3016-20	WEIGHT 110 LBS
0° DEFLECTION		
THROW 79'	P.D. .12	NC 29
22 1/2° DEFLECTION		
THROW 61'	P.D. .13	NC 30
45° DEFLECTION		
THROW 36'	P.D. .18	NC 36

QTY TAG

JOB NAME

CURBS PLUS, INC.
www.curbs-plus.com