

EQUIPMENT SCREENING INSTALLATION INSTRUCTIONS

STEP 1. INSTALL THE SUPPORT RAIL CLIPS ON THE SHORT SIDE OF THE ROOF CURB. (3) PER SHORT SIDE. BEFORE UNIT INSTALLATION.

NOTE: IF GASKET (SUPPLIED BY OTHERS) IS BEING INSTALLED ON TOP OF THE ROOF CURB MAKE SURE THAT IT GOES OVER THE TOP OF CLIPS.

Equally spaced.

INSTALL FASTENERS 4 PER CLIP.

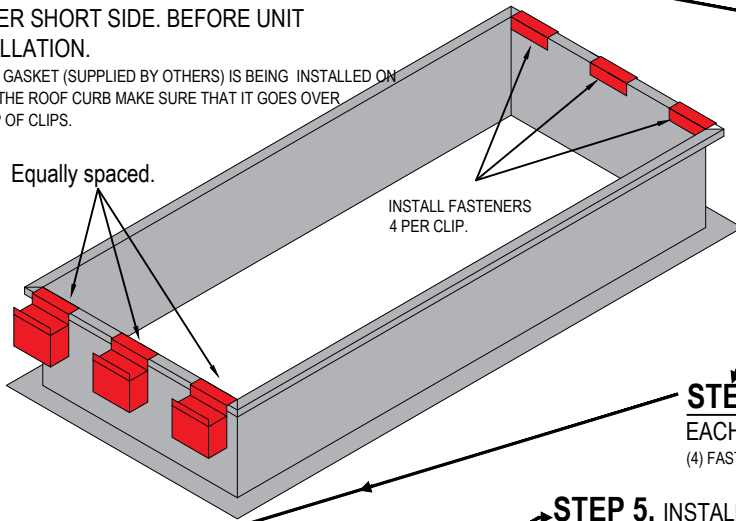

STEP 2. SLIDE THE SUPPORT RAILS INTO THE CLIPS. SLIDE THE RAILS TO THE DESIRED POSITION AND ATTACH TO THE CLIPS WITH TEK SCREWS.

INSTALL 2 TEK SCREWS PER CLIP TO LOCK SUPPORT CHANNELS IN PLACE

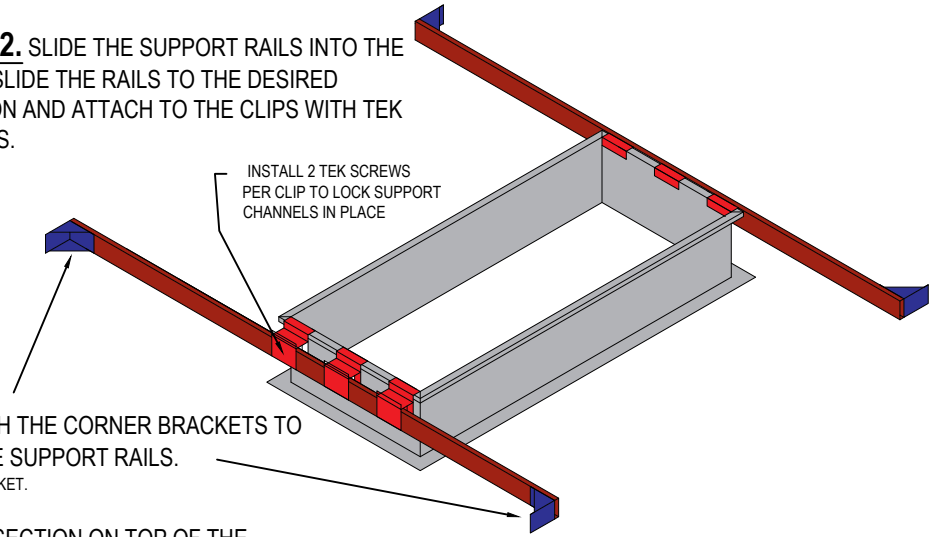

STEP 3. ATTACH THE CORNER BRACKETS TO EACH END OF THE SUPPORT RAILS. (4) FASTENERS PER BRACKET.

STEP 4. INSTALL THE WALL SUPPORT CHANNELS AND CORNER BRACKETS. ALLOW FOR THE PROPER SPACING FROM THE UNIT. (4) FASTENERS PER BRACKET.

SLOTTED BRACKETS

CORNER GUSSET (8) FASTENERS PER GUSSET

NOTE: IF THERE ARE ONLY 3 WALLS, SUPPORT CHANNELS WILL BE SUPPLIED FOR INSTALLATION ON THE END OF THE WALL AND ANGLED DOWN TO THE WALL SUPPORT CHANNELS.

INSTALL FASTENERS @ 12" O.C.

NOTE: THE FACTORY INSTALLED CORNER BRACKETS GO TO THE INSIDE OF SCREEN

WALL SUPPORT GUSSETS (8)- PER SCREEN

SLOTTED FOR ADJUSTMENT

CORNER FLASHING ATTACH WITH FASTENERS EVERY 12" O.C.

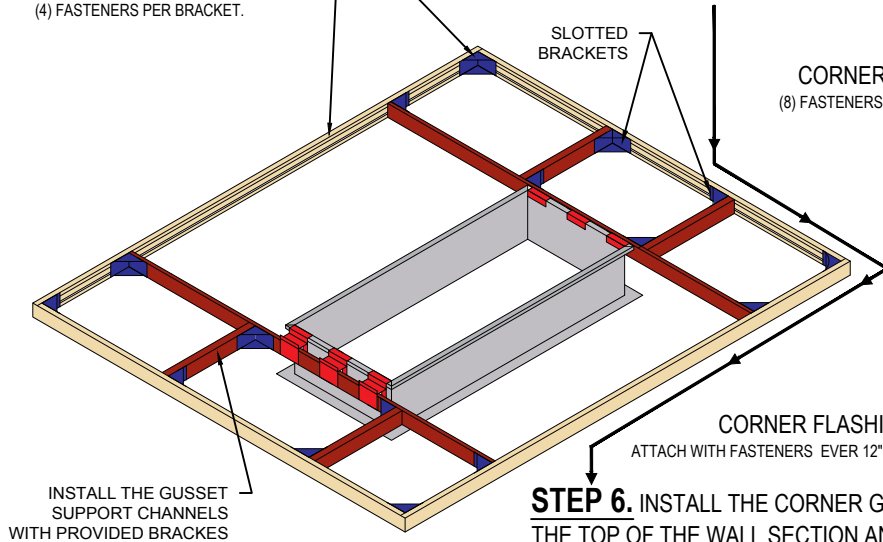

INSTALL THE GUSSET SUPPORT CHANNELS WITH PROVIDED BRACKES

STEP 5. INSTALL THE WALL SECTION ON TOP OF THE WALL SUPPORT CHANNELS. THE BOTTOM OF THE WALL SECTIONS WILL HAVE THE TRACK FOR THE DOOR PANELS UN-INSTALLED(SEE NOTE/DETAIL ON PAGE 2). PLACE FASTENERS @12" O.C. INTO THE LOWER SUPPORT CHANNELS.

STEP 6. INSTALL THE CORNER GUSSETS TO THE TOP OF THE WALL SECTION AND THE CORNER FLASHING TO THE OUTSIDE CORNERS. ALSO INSTALL WALL SUPPORT GUSSETS ON THE TUBING AS SHOWN (2-EACH SIDE).

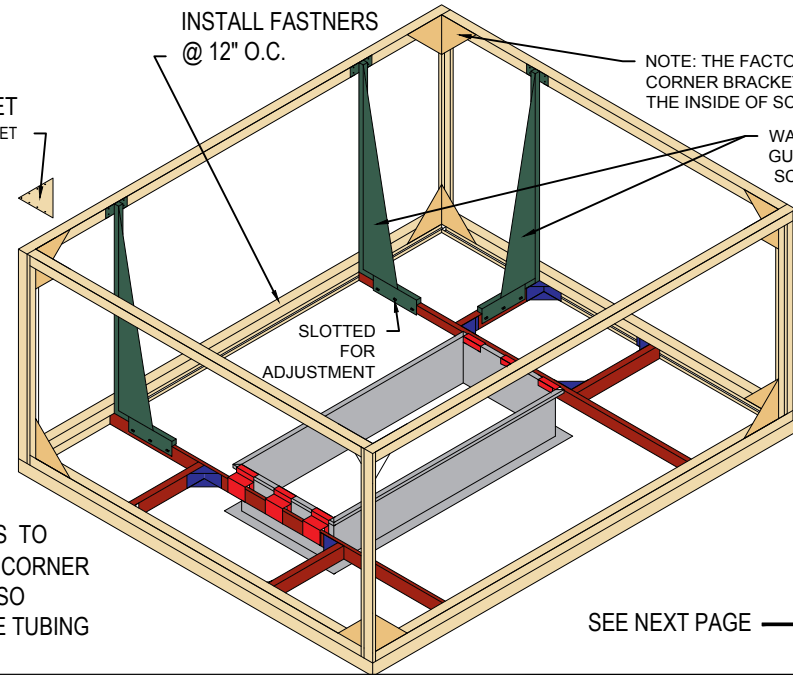

SEE NEXT PAGE →

STEP 7. PRESS THE BOTTOM SUPPORT TRACK INTO PLACE. (ONLY INSTALL THE LARGER TRACK SECTION AT THIS TIME.)

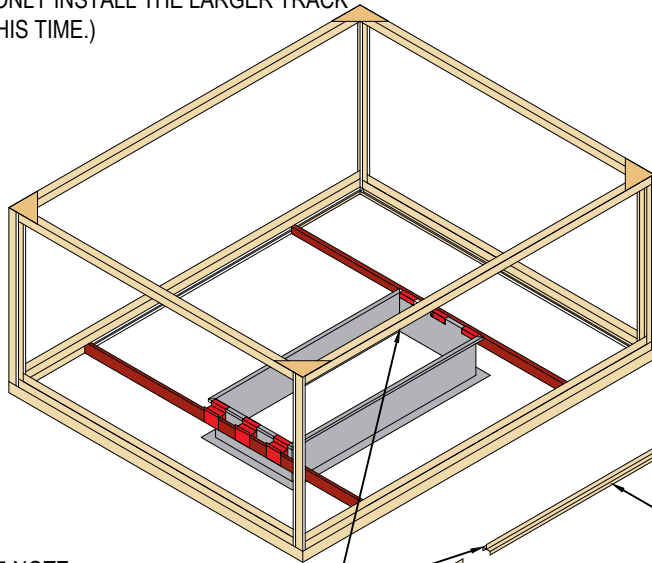

STEP 8. INSTALL THE WALL PANELS BY PLACING THEM INTO THE WALL SECTIONS WHERE THE TRACK SECTION HAVE NOT BEEN INSTALLED. AFTER ALL PANELS ARE IN PLACE, PRESS THE SMALL TRACK SECTIONS IN.

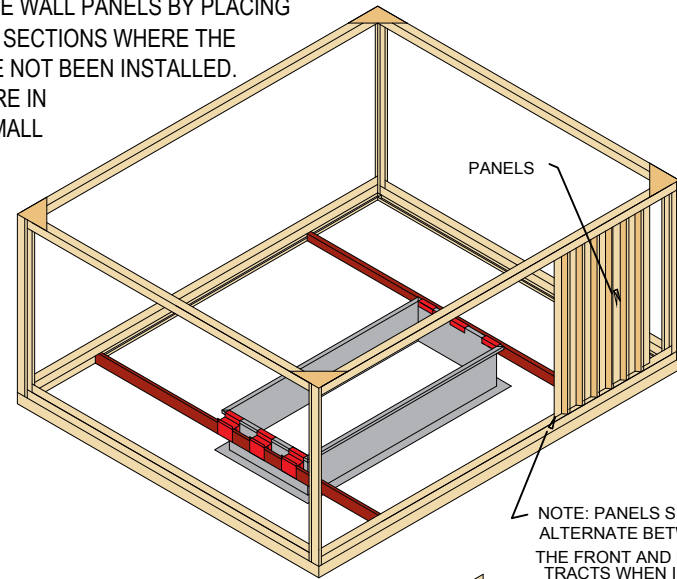

STEP 5 NOTE:
NOTE: THE TRACKS ARE PRE-INSTALLED BY THE FACTORY ON THE TOP SECTION OF THE SCREEN FRAME

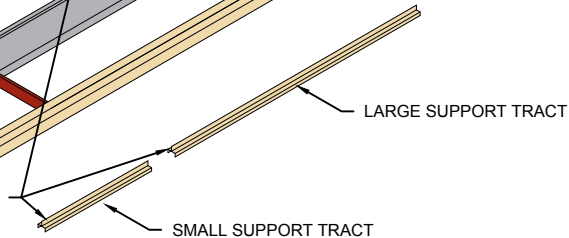

NOTE: PANELS SHOULD ALTERNATE BETWEEN THE FRONT AND REAR TRACKS WHEN INSTALLING TO ALLOW FOR A SLIGHT OVERLAP ON THE PANELS. (OVERLAPS WILL VARY ON THE SIZE OF THE SCREEN BUT IN GENERAL THE OVERLAPS WILL BE JUST A FEW INCHES)

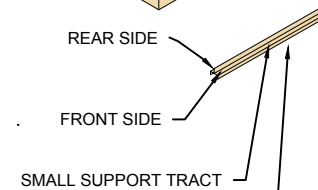

NOTE: INSTALL THE SMALL TRACKS AFTER ALL PANELS ARE INSTALLED

NOTE: FOR ANY INSTALLATION QUESTIONS, CONCERNS, OR JUST TO LEAVE FEEDBACK PLEASE CALL OR E-MAIL THE FACTORY @ STEVE.RODMAN@CURBS-PLUS.COM / 1-888-639-2872 OR CONTACT A MEMBER OF OUR DESIGN TEAM @ DRAFTINGDEPARTMENT@CURBS-PLUS.COM

Curbs Plus, Inc.
Sales Office
1-888-639-2872
www.curbs-plus.com

Manufacturing Locations
Ringgold, GA and El Dorado, KS

SUPPORT GUSSETS WILL ATTACH TO BOTH THE TOP AND BOTTOM WALL SECTIONS

NOTE: WHEN THE SCREEN HEIGHT IS LARGER THAN 78" A DOUBLE HEIGHT WALL SECTIONS MUST BE USED. THE TOP WALL SECTION WILL ATTACH TO THE BOTTOM WALL SECTION THE SAME AS THE STEP (5) WALL ATTACHMENT DETAIL. ALSO THE SCREENS WILL ATTACH THE SAME AS THE STEP (8) PANEL INSTALL DETAIL.

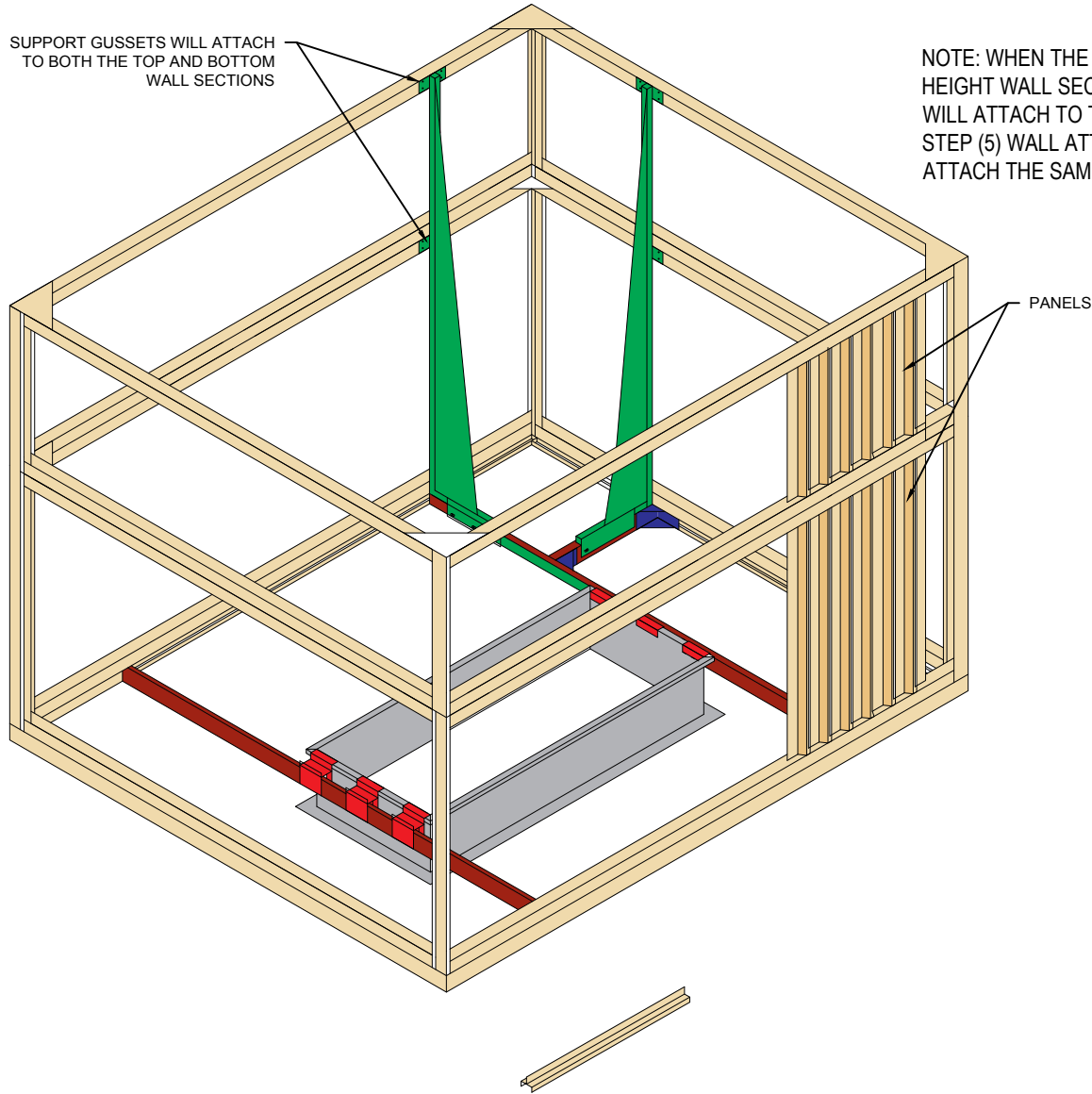

NOTE: FOR ANY INSTALLATION QUESTIONS, CONCERNS, OR JUST TO LEAVE FEEDBACK PLEASE CALL OR E-MAIL THE FACTORY @ STEVE.RODMAN@CURBS-PLUS.COM / 1-888-639-2872 OR CONTACT A MEMBER OF OUR DESIGN TEAM @ DRAFTINGDEPARTMENT@CURBS-PLUS.COM

Curbs Plus, Inc.

Sales Office
1-888-639-2872

www.curbs-plus.com

Manufacturing Locations
Ringgold, GA and El Dorado, KS