

DRUM LOUVER PLENUM-DIFFUSER

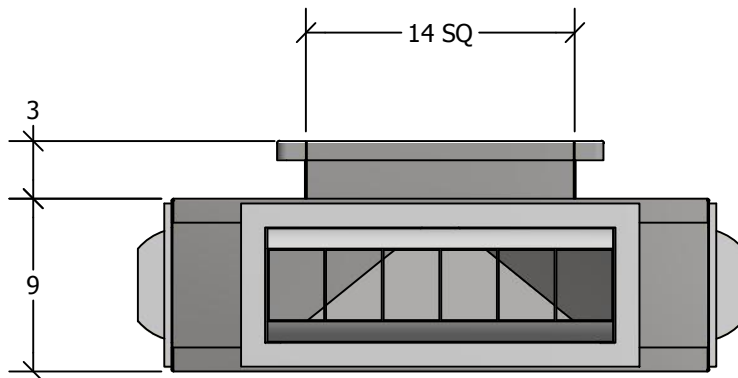

STANDARD FEATURES

1. G-90 Galvanized Steel Construction.
2. Turning Vanes in Each Quadrant.
3. 1" 1-1/2 lb. Duct Liner.
4. Vertical and Horizontal Adjustable Drum Louver.
5. Fully Assembled
6. TDC Duct Connections Provided.
7. 3/8" Threaded Inserts for Mounting Available.
8. Engineered Curb and Duct Packages Available.

NOM CFM 2,000	MODEL NO DLPD3 1806-5	WEIGHT 69 LBS
0° DEFLECTION		
THROW 34-59	P.D. .299	NC 36
30° DEFLECTION		
THROW 23-40	P.D. .5382	NC 44

QTY TAG

JOB NAME

CURBS PLUS, INC.
www.curbs-plus.com